

# Trademark Generation II Series Intercom System Installation and Operation Reference Guide

[www.escoservices.com](http://www.escoservices.com)

Components: Desktop Controller, Digital Interface Box, 4-Speaker I/O Card, DC Power Supply and Cord

## Description:

ESCO's Trademark Generation II Series Intercoms come with either an 8 or 20 speaker interface. These systems are easily upgradeable to up to 16 or 32 speaker stations by adding optional 4 Speaker I/O Cards. The base system uses a single Desktop Controller with the ability to attach 15 more. Two voice channels allow communication for two speaker stations at once. The Digital Interface Box provides a convenient location for speaker and call switch terminals.

### Table of Contents

Specifications and Features .....	1
Status LCD and Membrane Keypad Switch functions .....	2
Island Mode Overlay and Instructions .....	3
Operating Instructions .....	3
How to Identify Trademark Series Intercom Generations .....	4
Entering and Navigating the Programming Menu .....	4
Assigning custom text descriptions to Desktop Controllers and Speaker Stations .....	4
Menu Descriptions .....	5
Recommended Interconnect Cable .....	7
Installation guidelines .....	8
Installation of music or message player .....	8
Installation of additional (0941-0108) 4 speaker I/O cards .....	9
Gilbarco Applause troubleshooting .....	9
System Interconnect wiring diagram .....	10
Speaker Station wiring diagram .....	11
Desktop Controller External Microphone and Speaker wiring diagrams .....	12

## Specifications:

- ★ Connect up to 32 wired Speaker Stations and up to 16 Desktop Controllers
- ★ Desktop Controller size: 8.0" D (203mm) x 5.75" W (146mm) x 2.75" H (70mm) (including feet)
- ★ Digital Interface Box size: 8.25" D (210mm) x 10.0" W (254mm) x 4.375" H (111mm) (including mounting tabs)
- ★ 120 Volt AC stepped down to regulated DC via UL approved desktop power supply

## Features:

- |  |  |
|--|--|
| ★ User friendly operation                                    | ★ Monitor selected speakers or silent standby            |
| ★ Dual channel communication (2 conversations at once)       | ★ Hold memory  |
| ★ Remote to Remote communication                             | ★ 18" detachable gooseneck microphone                    |
| ★ VOX (Voice Activated "hands free" talk switching)          | ★ Backroom mountable speaker interface                   |
| ★ Large LCD displays station and call status                 | ★ Small footprint Desktop Controller                     |
| ★ Dry contact call input                                     | ★ All line paging (capable of disabling select speakers) |
| ★ Individual talk out speaker station digital volume control | ★ Message / Music (capable of disabling select speakers) |
| ★ Message / Music digital volume control                     | ★ Assign up to 16 characters to label speaker locations  |
| ★ Adjustable alert beeper tone volume                        | ★ Assign call priority to a speaker station              |
| ★ Chemical resistant long-life membrane keypad               | ★ Individual or total message / music mute               |
| ★ One touch answer   | ★ Dedicated output amplifier for each speaker            |

NOTE: This equipment has been tested and found to comply with the limits for a Class A digital device, pursuant to Part 15 of the FCC Rules. These limits are designed to provide reasonable protection against harmful interference when the equipment is operated in a commercial environment. This equipment generates, uses, and can radiate radio frequency energy and, if not installed and used in accordance with the instruction manual, may cause harmful interference to radio communications. Operation of this equipment in a residential area is likely to cause harmful interference in which case the user will be required to correct the interference at his own expense.

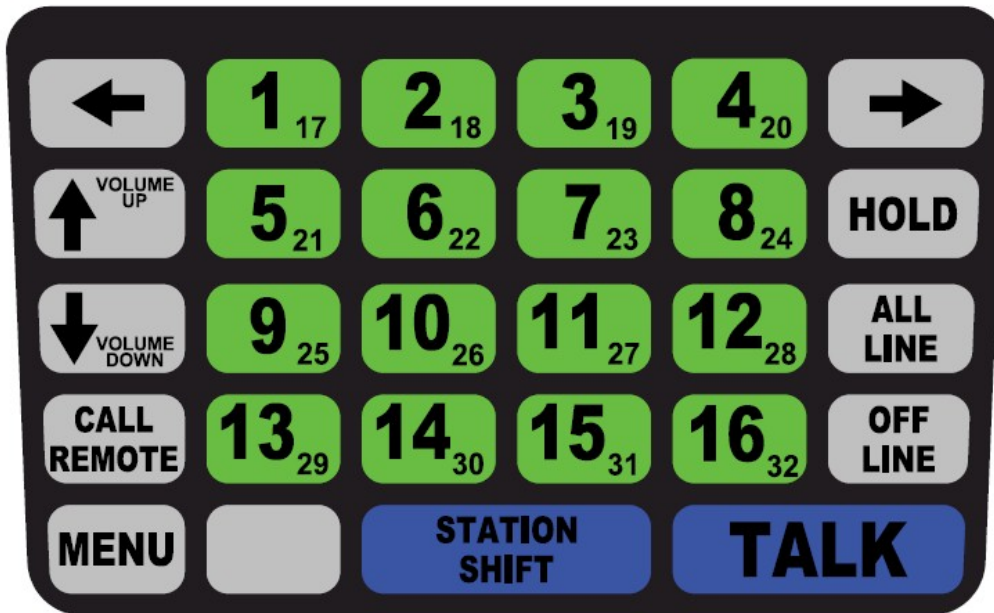

**Status LCD and Membrane Keypad Switch functions:**

	Speaker stations 1 thru 16 are selected with a single key press. Speaker stations 17 thru 32 are selected by first pressing the STATION SHIFT key followed by the appropriate station select key.
	Depressing this switch followed by pressing a station select key allows operator to select speaker stations 17 thru 32.
	Press and hold this switch to talk to a speaker station release to listen. Status LCD indicates: TALK / LISTEN state. <i>(Acts as the ENTER key during programming.)</i>
	Deactivates all stations. Intercom should remain in this mode when not in use. Status LCD indicates: OFF LINE mode. <i>(Used to back up through programming levels.)</i>
	Press and hold this switch while talking to broadcast page to all enabled stations simultaneously.
	Depressing HOLD causes station status LCD to display HOLD followed by the number of held stations as a reminder of previously active stations. Status LCD indicates HOLD followed by the number of stations placed on hold.
	Depressing this switch followed by pressing a station select key allows operator to call remote selectors 1 thru 16.
	Depressing this switch increases Listen volume. Status LCD indicates volume level (1 – 15). <i>(Used to increment numbers, letters or to scroll to Station or Remote #'s in programming.)</i>
	Depressing this switch decreases Listen volume. Status LCD indicates volume level (1 – 15). <i>(Used to increment numbers, letters or to scroll to Station or Remote #'s in programming.)</i>
	Depress the MENU switch and enter security code (2, 3, 6, 7) allows access to configuration menu.
	Depressing this switch allows the installer to scroll forward through the menu descriptions. <i>(Used to move forward through programming menu items.)</i>
	Depressing this switch allows the installer to scroll backward through the menu descriptions. <i>(Used to move backward through programming menu items.)</i>

## Island Mode Overlay and Instructions

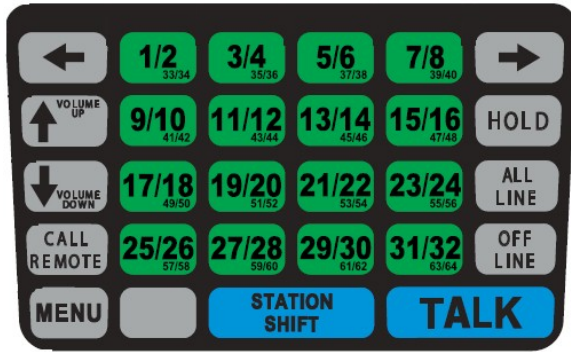

- Island Mode Overlay ESCO #0503-1546 can be purchased separately.
- Removed paper backer from overlay and carefully place over original keypad overlay.
- If necessary, the text displayed when a speaker station is selected can be modified by using the “Assign Text to Speaker Station” menu feature. Instructions to use this feature are on pages 4 & 6.

## Operating Instructions

- Speak naturally into the microphone at a distance of about two inches.
  - Touch the keys with pads of your fingers (Do not use hard or sharp objects).
- 1. Turn On / Turn Off**
    - The power switch is located on the Digital Interface Box. The Desktop Controller will power up in the “OFF LINE” mode.
  - 2. Select a speaker station while in Off Line mode**
    - Press a speaker station number for stations 1 – 16  
(Press STATION SHIFT and a speaker station number for stations 17 – 32)
    - Selecting a station will immediately place the intercom into the LISTEN mode.
    - Press and hold the TALK button while talking out to selected speaker, or talk directly into microphone if the VOX option has been enabled.
    - Release the TALK button to listen to the selected speaker.
    - After conversation is complete press OFF LINE to return the intercom to OFF LINE Standby  
(If the automatic standby option is selected the intercom will return to either OFF LINE Standby or Monitor All Line mode after a 5 minute delay).
  - 3. Adjust the Desktop Controller listen volume**
    - While connected to a speaker station, press the UP Arrow to increase the listen volume or press the Down Arrow to lower the listen volume.
    - If the Monitor All Channels mode is enabled a second volume adjustment is available. While in Monitor Standby press the UP Arrow to increase the Monitor All Channels volume or press the Down Arrow to lower the Monitor All Channels volume.
  - 4. Answer a call from a speaker station**
    - The intercom will beep and flash the word Call\_\_ followed by the number of waiting call requests in the lower right corner of the LCD screen (Call01 indicates one speaker station is calling, Call03 indicates that there are three stations calling)
    - Press the TALK button to active the first speaker calling; after the conversation is complete press OFF LINE to return to OFF LINE Standby. The intercom will beep again if there are additional calls waiting. Call requests will be answered in the order they were placed.
  - 5. Page all stations**
    - Press and hold the ALL LINE button while talking out to all the speakers simultaneously. Releasing the ALL LINE” button will return the intercom to the previous mode it was in.
  - 6. Call a Station remote**
    - Press the REMOTE SHIFT followed by a remote number 1 – 16.
  - 7. Place system in OFF LINE Standby**
    - Press OFF LINE to return the intercom to OFF LINE Standby  
(If the automatic standby option is selected the intercom will return to either OFF LINE Standby or Monitor All Line mode after a 5 minute delay).
  - 8. Place a call on HOLD**
    - If it is necessary to place a speaker station on hold to answer additional calls press the HOLD button. The word Hold\_\_ followed by the number of on hold speaker stations will flash in the lower left corner of the LCD screen. While in OFF LINE press the HOLD button to recall held stations in the order they were placed on hold.

### How to identify Trademark Series Intercom Generations:

**Important note:** First and second generation Desktop Controllers, Digital Interface Boxes and 4-Speaker I/O Cards are not interchangeable.

#### **Trademark Generation I Intercom**

- TMK-3000 Desktop Controller
  1. Model number = TMK-3000
  2. Serial number will start with "IC"
  3. "TALK" and "STATION SHIFT" buttons are blue.
  4. Printed circuit board is green.
- DIB-3004 & DIB-3008 Digital Interface Boxes
  1. Model number = DIB-3004 and DIB-3008
  2. Serial number will start with "IC"
  3. Metal enclosure is painted gray.
  4. Printed circuit board is green.
- (0941-0063) 4 speaker I/O card
  1. Printed circuit board measures 3 ¼" x 4 ¼"
  2. Printed circuit board is green.

#### **Trademark Generation II Intercom**

- TMK-4000 Desktop Controller
  1. Model number = TMK-4000
  2. Serial number will start with "SG"
  3. "TALK" and "STATION SHIFT" buttons are red.
  4. Printed circuit board is blue.
- DIB-4004 & DIB-4008 Digital Interface Boxes
  1. Model number = DIB-4004 and DIB-4008
  2. Serial number will start with "SG"
  3. Metal enclosure is painted red.
  4. Printed circuit board is blue.
- (0941-0108) 4 speaker I/O card
  1. Printed circuit board measures 3 ¼" x 5 ¼"
  2. Printed circuit board is blue.

## Entering and Navigating the Programming Menu

Press the **MENU** key

The screen will display ENTER PASSWORD

Press: **2,3,6,7** When using an Island Mode Overlay press: **3/4, 5/6, 11/12, 13/14**

The screen will display the first menu item. Use the **RIGHT** arrow key to move forward, and the **LEFT** arrow key to move backward through the menus until the desired menu item is displayed.

Press the **TALK** key to enter menu item.

Flashing fields indicate changeable items,

The **UP** and **DOWN** arrow keys are used to increment numbers, letters or to select Station or Remote #'s.

Press the **TALK** key to enter selected change variable.

To return to the main menu, press the **OFF LINE** key one to two times, depending on menu level.

To exit programming mode, just press the **MENU** key. Display will return to the stand-by screen.

## Assigning custom text descriptions to Desktop Controller and Speaker Stations

Custom 16 character descriptions can be assigned to all Remote and Speaker stations.

1. In programming scroll to either the Assign Text to Desktop Controller or Assign Text to Speaker Station programming functions and press TALK to enter.
2. Using the **UP ARROW** and **DOWN ARROW** scroll to the Station number to customize and press the TALK button to enter the text customizing area.
3. Using the **UP ARROW** and **DOWN ARROW** scroll to the desired character and press TALK to enter and advance the cursor to the next character position.
4. While assigning characters pressing the STATION SHIFT button will change the character selection to either: Upper Case Alpha Characters, Lower Case Alpha Characters, Numeric Characters, Special Characters/ Punctuation.

(Special Characters/Punctuation start with the space character and advance as follows while pressing the **UP ARROW**)

SPACE	,	.	*	/	-	_	(	)	\$	!	@	#	%	+	&	:		'	?	{	}
-------	---	---	---	---	---	---	---	---	----	---	---	---	---	---	---	---	--	---	---	---	---

5. After customizing the text press TALK repeatedly to advance to the descriptions end. Pressing TALK one more time will advance to the next station description to customize automatically.
6. To exit programming mode, just press the **MENU** key. Display will return to the stand-by screen.

## Menu Descriptions:

### 1) **Assign Address to Station Remote**

Each Desktop Controller requires a unique address number. These numbers give each Desktop Controller its identity.

1A) **Remote ID Address** (Default = 01) (Available addresses 01-16)

### 2) **Quantity of Speakers Installed**

The system will sense the quantity of installed I/O cards and will default to the maximum number of available speaker circuits accordingly. The quantity of speakers can be set to a lower number if less than the maximum is installed to avoid the possibility of connecting to an unwired station.

2A) **Speaker Quantity** (Default = The quantity of I/O cards installed x 4) (Available quantity 01-32)

### 3) **Stations Disabled During "All Line"**

Any Speaker Station requiring privacy during an All Line Paging/Listen situation can be disabled. This function disables All Line Paging outgoing as well as All Line Listen incoming communications.

3A) **Station** (01) (Default = All Enabled)  
Scroll to desired Speaker Station and select Disable

### 4) **Stations Disabled During "Music"**

When the intercom is in the Off Line Standby mode it is capable of transmitting background music or messaging. If there are Speaker Stations requiring silence during Off Line Standby they can be disabled.

4A) **Station** (01) (Default = All Enabled)  
Scroll to desired Speaker Station and select Disable

### 5) **Disable Calls from Speaker Stations** (Default = Enabled) **Audio request tone only**

The Desktop Controller will receive all incoming audio call requests from any Speaker Station as well as any additional Desktop Controller. If an individual Desktop Controller is in a location where the audio call alerts from the Speaker Stations are unsuitable, they can be disabled. When Speaker Station calls are disabled the Desktop Controller will only receive audio call requests from other Desktop Controller and only visual call requests from the Speaker Stations.

5A) **Station Call** (Default = Enable)

### 6) **Adjust Volume of Alert Beeper Tones**

Adjust the volume of the Alert Beeper Tones generated by Calling Speaker Stations, Busy signals, Key presses and Errors.

6A) **Alert Tone Volume** (Default = 08) (Available volume range 01-15)

### 7) **Enable Microphone VOX Circuit**

The outbound talk circuit can be activated by pressing and holding the Talk button on the Desktop Controller or utilizing the built-in VOX circuit if it is enabled and properly adjusted. If this parameter is disabled the next menu item will be skipped over.

7A) **Enable VOX** (Default = Disable)

### 8) **Adjust Microphone VOX Sensitivity**

The microphone VOX circuit requires adjusting to accommodate voice switching levels. The range of adjustments is 1 through 15, 15 being the most sensitive. The VOX circuit will sense voice activity at the microphone and activate the talk out circuit. If the VOX circuit is adjusted to low it may not activate unless you speak extremely loud. In reverse if the circuit is adjusted to high it may remain active due to ambient background noise. During the process of adjusting the VOX circuit there is a visual prompt that will change giving you feedback to the level of adjustment acquired.

8A) **VOX Sensitivity** (Default = 08) (Available sensitivity range 01-15)

### 9) **Adjust "Talk-Out" Volume**

The Talk Out Volume can be adjusted to one global volume and then if additional adjustments are necessary the volume can be raised or lowered for individual speaker stations.

9A) **Adjust Global**

- **Global Volume** (Default = 08) (Available volume range 01-15)  
The volume of all the Speaker Stations are adjusted simultaneously.

- **Station XX Volume YY**  
Additional adjustments can be made to Speaker Stations raising or lowering the volume.  
*If the Global adjustment feature is used after individual adjustments are made all individual adjustments are lost.*

10) **Adjust "Music" Volume**

While the intercom is in Off Line Standby it is capable of transmitting background music or messaging. This adjustment sets the volume for all the speakers that are selected for background Music / Messaging.

10A) **"Music" Volume** (Default = 08) (Available volume range 01-15)  
Individual speaker volume adjustment is not available.

11) **Automatically Reset to OffLine (Standby)**

If this feature is enabled the system will return to Off Line (Standby) after a delay of 300 seconds if the Talk switch is not pressed or the VOX circuit is not activated. If this feature is disabled the selected station will remain active in the Listen state until the Off Line button is pressed.

11A) **Auto OffLine** (Default = Enable)

12) **Silent OffLine or Monitor All Channels**

If this feature is set for Silent the intercom remote will be totally silent during Off Line Standby. If the feature is set for Monitor the intercom will monitor all Speaker Stations that are not disabled during All Line Page while in Off Line Standby.

12A) **Standby Mode** (Default = Silent) (Other available feature = Monitor)

13) **Assign Text to Station Remote**

Each attached Desktop Controller will have a default description consisting of the word Remote # followed by its assigned address. This description can be changed to better describe the Desktop Controllers location. The description can utilize up to 16 characters.

13A) **Select Remote** (Default = Remote # 01)  
This feature allows scrolling through Remotes to select which to reassign text.

13B) **Reassign Text**  
Refer to: Assigning custom text descriptions to Desktop Controller and Speaker Stations (Page 4)

14) **Assign Text to Speaker Station**

Each attached Speaker Station will have a default description consisting of the word Station # followed by its assigned address. This description can be changed to better describe the Speaker Stations location. The description can utilize up to 16 characters.

14A) **Select Station** (Default = Station # 01)  
This feature allows scrolling through Speaker Stations to select which to reassign text.

14B) **Reassign Text**  
Refer to: Assigning custom text descriptions to Desktop Controller and Speaker Stations (Page 4)

15) **Synchronize Programming**

If any of the default parameters have been changed and there are additional Desktop Controllers, the programming can be synchronized to eliminate the need to program the additional Desktop Controllers separately. All data is synchronized except for the Desktop Controllers ID number, any Station Calls that are disabled.

15A) Press "TALK" to Sync

16) **Restore System Default Values**

Restores values to factory original settings

17) **Software Versions**

The Remote Selector and I/O Controllers software versions are displayed at this screen

18) **Station Priority** (Default = Disable)

If this feature is left Disabled the Calls from the Speaker Stations will be answered the order they are received. A single Speaker Station can be selected to take call priority over all other Speaker stations.

19) **Restrict Access** (Default = Disable)

- a) Enable this feature and make selected Speaker Stations and Remotes unavailable from this Remote.
- b) Selecting a restricted Speaker Station or Remote will display Error Message ACCESS RESTRICTED
- c) If a Call is generated from a Restricted Speaker Station or Remote the system will function as normal.
- d) All Call and All Listen communications function per setting in (Menu 3)

20) **Total Music Mute** (Default = Disable)

While talking to a Speaker Station the background music will continue to play on all remaining unused Speaker Stations. If this feature is enabled the background music will be turned off totally any time the intercom system is not in Off Line Standby.

**Recommended Interconnect Cable:**

**DO NOT UNDER ANY CIRCUMSTANCES ROUTE AUDIO OR DATA CABLES IN THE SAME CONDUIT WITH 120VAC WIRING. THIS VIOLATES THE NATIONAL ELECTRIC CODE AND PRESENTS A HAZARD.**

All speaker cable must be of a shielded / twisted-pair type containing 22 to 14 gauge wire. Cable shields should be attached to the shield ground connections at the Digital Interface Box only. Use of shielded / twisted pair cable provides clearest communication and easiest connection to each Sub-Station speaker. All speaker cables must be routed through a conduit that is **SEPARATE** from those containing 120VAC power wiring.

**Basic wiring paths** *All wire cables must include a drain wire.*

- A.) Digital Interface Box Voice Channel wires to Desktop Controller  
*Wire only "Voice Channel A" when using one Desktop Controller. (2 wires)*  
*Wire both "Voice Channels A & B" when using multiple Desktop Controllers (4 Wires)*
- B.) Digital Interface Box RS-485 data wires to Desktop Controller (4 Wires)  
*RS485 wiring must have all four connections completed to each component.*
- C.) Outside Speaker to Digital Interface Box (2 Wires)
- D.) Call switches to Digital Interface Box (2 Wires)
- E.) Music/message source to Digital Interface Box (2 Wires)

**Select wire size (gauge) and number of conductors** *All wire cables must include a drain wire.*

For Digital Interface Box (DIB) Voice Channel to Desktop Controller Box choose wire conductor # and gauge below. Repeat for Outside Speaker, Handset or Call Switch wire conductor # and gauge.

**To wire:**

- Digital Interface Box (DIB) Voice Channel to Desktop Controller.
- Outside Speaker or Handset.
- Call Switch.

**Use 2 conductor twisted pair shielded w/drain**

- Less than 300 feet use 22 AWG or larger
- Less than 500 feet use 20 AWG or larger
- Less than 750 feet use 18 AWG or larger
- Less than 1200 feet use 16 AWG or larger
- Less than 2000 feet use 14 AWG
- Wire length over 2000 feet (not recommended)

**To Wire:**

- Digital Interface Box (DIB) RS-485 to Desktop Controller.

**Use 4 conductor twisted pair shielded w/drain**

- Less than 60 feet use 22 AWG or larger
- Less than 100 feet use 20 AWG or larger
- Less than 160 feet use 18 AWG or larger
- Less than 250 feet use 16 AWG or larger
- Less than 400 feet use 14 AWG
- Wire length over 400 feet (not recommended)

### **Installation guidelines:**

- A) The power supply connected to the interconnect box should have a dedicated grounded 120VAC line.
- B) Speaker hook-up wire should be 22 to 14 gauge shielded twisted pair w/drain cable.
- C) Voice Channel hook-up wire should be 22 to 14 gauge shielded twisted pair w/drain cable.
- D) RS-485 hook-up wire should be should be 22 to 14 gauge shielded twisted pair w/drain cable.
- E) Run speaker cable / data wires separately away from high voltage power wiring.
- F) Sub-station speakers mounted in close proximity of a Master-station may result in a howl (acoustical feedback) when either one calls the other. This condition can be corrected by lowering volume or repositioning the substation speaker.
- G) The use of ESCO Speakers and Call switches is recommended for optimum performance.
- H) Mount Speakers and Call switches according to their installation and application guide.

### **Installation of the Esco Trademark Generation II Series Intercom:**

- 1) Find a suitable non-hazardous location to install the **Digital Interface Box**. It can be mounted either under a counter or in the backroom.
- 2) Run an appropriate length of speaker cable from each remote speaker and call switch to the area where the intercom **Digital Interface Box** is located. (Tagging wire ends is recommended to avoid confusion when the final connections are made).
- 3) Connect speaker and call switches to an assigned location on a **4-Speaker I/O Card**; (see wiring diagram on page 10). (If recommended shielded speaker cable is used be sure to tie shield drain to the Shield/Ground terminal of the **4-Speaker I/O Card**).
- 4) Firmly plug the supplied Gooseneck Microphone into the socket on the top right of the **Desktop Controller** until the latch clicks into place.
- 5) The **Desktop Controller** can be placed on a counter or mounted to a wall utilizing three key slot mounting holes on the bottom.
- 6) Connect RS-485 wires from the **Digital Interface Box** to each **Desktop Controller**; (see wiring diagram on page 9). (If shielded cable is used be sure to tie shield drain to the RS-485 Shield/Ground terminal of the **Digital Interface Box**).
- 7) Connecting voice channel interconnect wiring; (see wiring diagram on page 9).
  - Systems with a single **Desktop Controller** require wiring to voice channel "A" only.
  - Systems utilizing multiple **Desktop Controllers** require wiring to both voice channels "A" & "B". (When using multiple **Desktop Controllers** each controller must be programmed with a unique address assigned via programming (01-16). (If recommended shielded cable is used be sure to tie shield drain to the Shield/Ground terminal of the **Digital Interface Box**).
- 8) Plug the power supply into a dedicated grounded 120VAC outlet and plug into the **Digital Interface Box**.
- 9) Turn the power switch on at **Digital Interface Box**. At this time, it is recommended to enter programming and "**Restore System Default Values**".
- 10) Check the operation of all connected speakers and call switches to each **Desktop Controller**. If the talk out volume is too low or there is acoustical feedback present, adjust the talk out speaker volume accordingly per programming instructions.
- 11) Check the sensitivity of the VOX circuit. A proper adjustment should trip the intercom into the talk mode when speaking in a normal voice into the microphone from a distance of 1 to 2 inches. The VOX sensitivity adjustment is located in programming menu under Adjust Microphone VOX Sensitivity.

### **Installation of music or message player:**

Music and/or prerecorded messages may be transmitted to all remote stations (enabled) that are in the standby mode.

Attach a 1000mv PP output of a message player / external amplifier to the music input and adjust the volume in programming. Speaker stations not requiring music can be disabled in programming

(Activating any remote channel mutes the music or message to that channel only unless the Total Music Mute feature is enabled).



**(0941-0108) 4 speaker I/O cards installation instructions:**

- Two additional (0941-0108) 4 speaker I/O cards can be added to an 8 station DIB-4008 Digital Interface Box enabling communication with up to 16 speaker stations. **If more than 16 speaker stations are required when adding on to an 8 station DIB-3008 Digital Interface Box it will be necessary to return the system to ESCO for upgrading.**
  - Three additional (0941-0108) 4 speaker I/O cards can be added to a 20 station DIB-4020 Digital Interface Box enabling communication with up to 32 speaker stations.
1. Power system down.
  2. Remove top cover of Digital Interface Box.
  3. **Important:** Additional I/O card must be installed into next available open card slot.
  4. Clip out card slot blanking cover and discard.
  5. Install (0941-0108) 4 speaker I/O card by removing mounting screw and 4 speaker connectors from card and plugging into next available slot.
  6. Secure (0941-0108) 4 speaker I/O card to mounting box with mounting screw.
  7. Reinstall top cover of Digital Interface Box.
  8. Install addition speaker and call button wiring per system installation instructions.
  9. Power system up.
  10. Once the system is powered up you will need to go to the Desktop Controller, enter programming mode and perform “**Restore System Default Values**” to enable the new I/O cards features.
  11. Program system per installation instructions.

**Gilbarco Applause General Operation:** The Applause intercom boards (M09750A002 & M14595A00) work by “listening” for activity from the intercom base station. By default, the speaker will be attached to the Applause system until there is activity from the intercom base station. When the intercom operator speaks out to the dispenser the Applause intercom board will switch control of the dispenser’s speaker to the intercom for 10 seconds. After 10 seconds of inactivity from the intercom the speaker will be switched back to the Applause system.

**Troubleshooting:**

1. If the dispenser is not equipped with the Applause system it is recommended to bypass the Applause intercom board and wire direct to the speaker.
2. If the intercom has no incoming listen activity at the Desktop Controller. It is necessary to select a speaker channel and talk out before the Applause system will connect the speaker to the intercom.
3. If the intercom is not activating the Applause system ensure the operator is speaking loud enough or raise the outgoing volume of the intercom system.
4. To qualify the interconnect wiring to the dispenser, try temporarily bypassing the Applause system and wire direct to the dispenser speaker.
5. Background music from the intercom system is not compatible with the Applause system.
6. Both speakers cannot be wired together (Parallel) when using Applause intercom board # M14595A00.

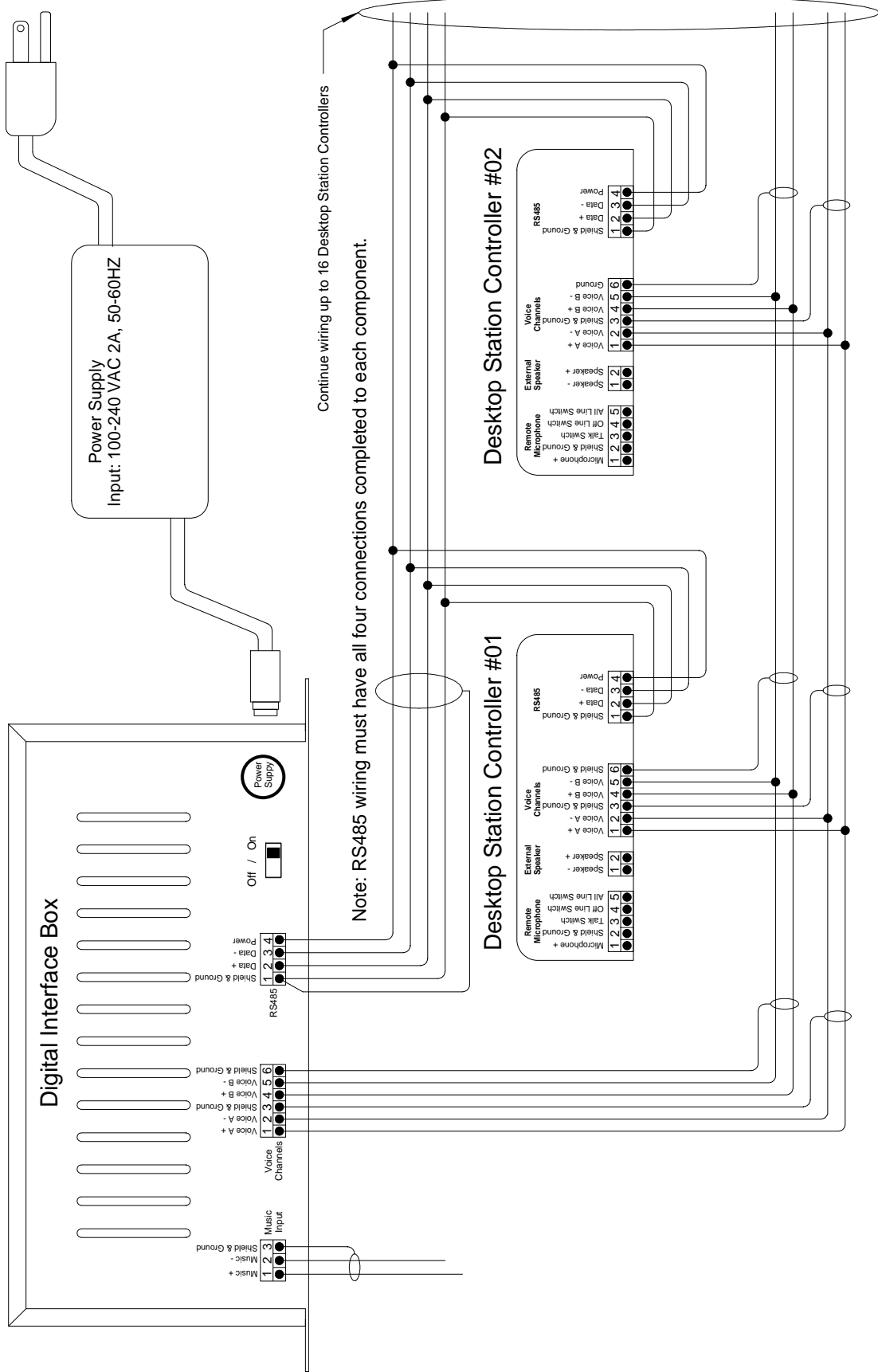

Continue wiring up to 16 Desktop Station Controllers

Note: RS485 wiring must have all four connections completed to each component.

Note: Wire only "Voice Channel A" when using one station selector.  
 Wire both "Voice Channels A & B" when using multiple station selectors.  
 Depending on distance use shielded, twisted pair, 14-22 AWG audio cable.

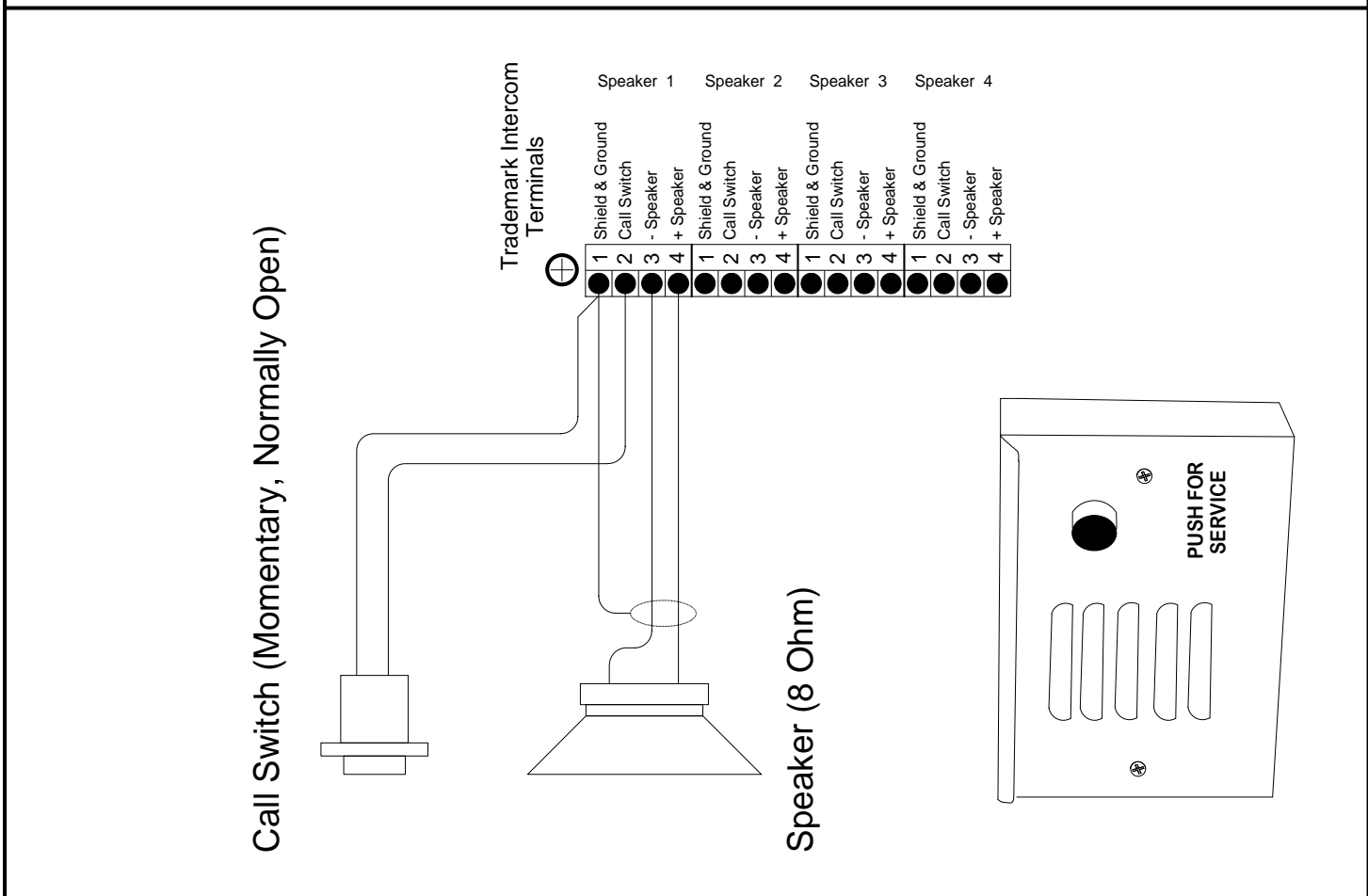
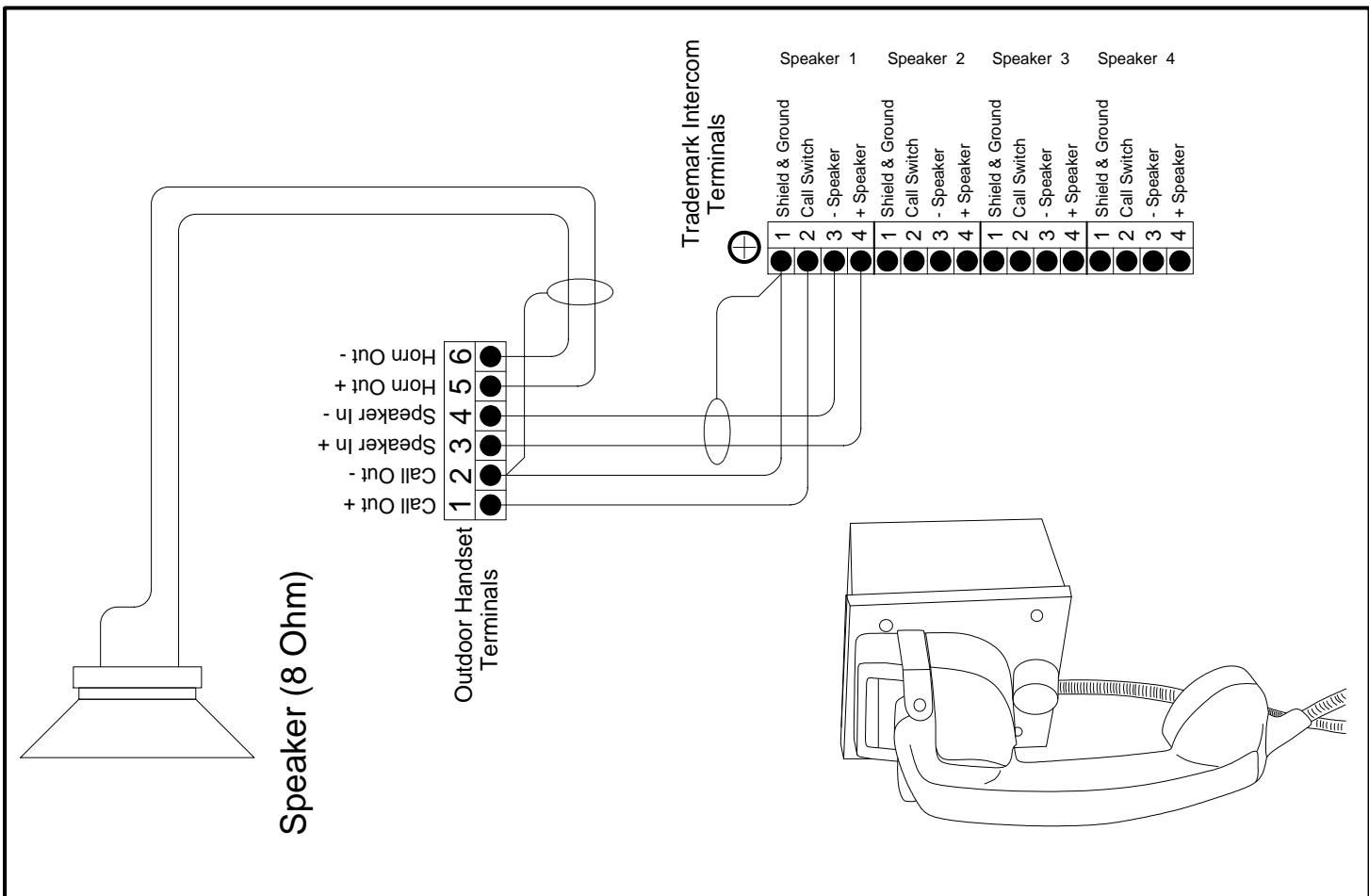

## Desktop Station Controller

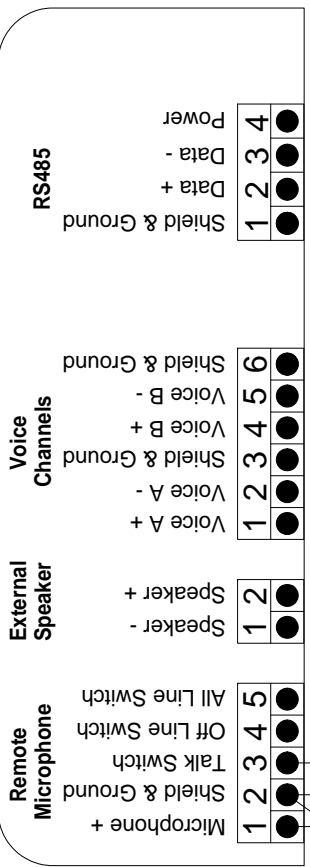

Note: The microphone switch can be wired to activate either the Talk, Off-Line or All Line function.

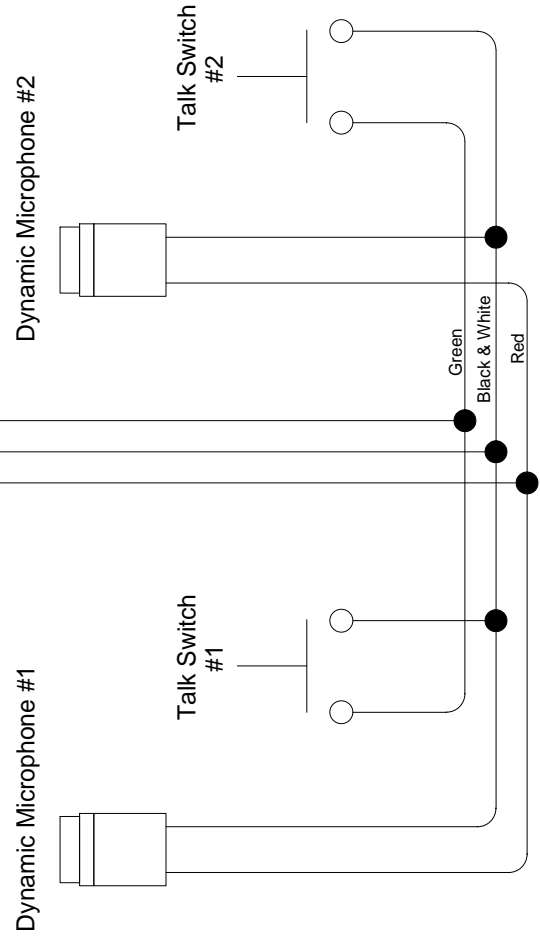

**Wiring for:  
Dual Remote Microphones  
with Switch**

## Desktop Station Controller

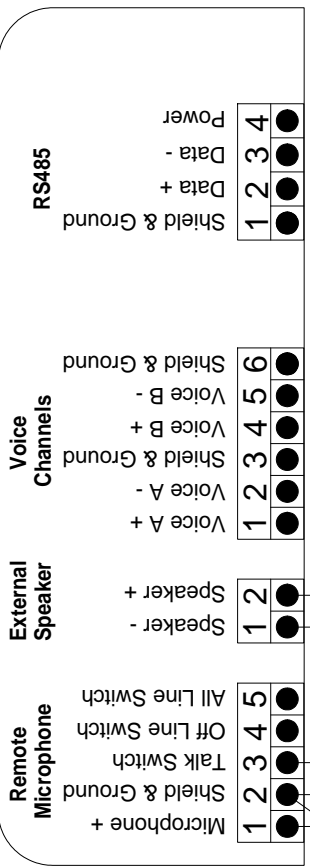

External Controller Listen Speaker  
(8 Ohm, Not a communication Channel)

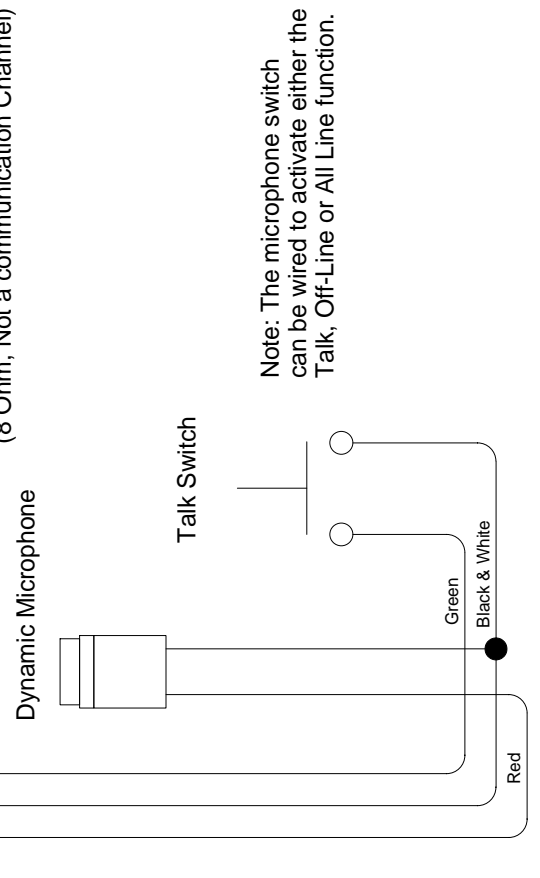

Note: The microphone switch can be wired to activate either the Talk, Off-Line or All Line function.

**Wiring for:  
External Controller Listen Speaker and  
Single Remote Microphone  
with Switch**